

Smooth Your Way With Sliders
Slide Your Way With

knockers

the best solution



"Sliding Revolution"

- Sliding
- Folding
- Hinge
- TV Lift
- Lock

furniture fittings

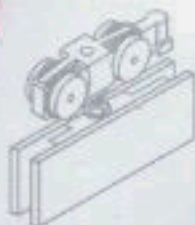

Welcome to Knockers world of architectural hardware and furniture fitting.

Knockers first established in Europe, developing, designing, and producing architectural hardware and furniture fitting. Later expand the market and production center in other part of the world.

Knockers is very passionate to contribute the solution to the ever limiting architectural space problem in modern living comfort.

Knockers managed to combine the high precision as well as innovative German technology with the lower cost of production in other part of the world to come up with the solution to larger population of the world.

Now Knockers is in Indonesia to bring to you the affordable German technology architectural hardware and furniture fitting.

We are more than happy to serve you in : Sliding

- *Vortfront*
- *Infront*
- *Frameless*
- *Soft close*
- *Synchro*
- *Telescopic*

Folding

- *Partition*
- *Cabinet*

Drawer Runner

- *Silent slide*
- *Tandem Push to open*
- *Tandem Slow Motion*

Hinge

- *Concealed Hinge*
- *Push to Open Hinge*
- *Soft Closing Hinge*
- *Profile Hinge*

TV Lift

- *Electrical Lift*
- *Rotating System.*

Lock

- *Drawer lock*
- *Roller Shutter lock*
- *Espangolett Lock*
- *Push Lock*
- *Lever Lock*
- *Central Lock*





- Door thickness** : 19 - 30 mm
Height adjustment : +/- 15mm
Material : Nylon running gear
 Inlaid carrier cup.
Running gear : Top running 2 roller
 with friction bearing mounted
Door stop : Top stop with guide retainer
 ★ *Soft Close Option*

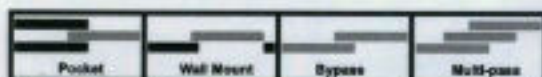

Type : DECO - 80
Max Weight 80 kg
 - For Wooden door
 - For Aluminium door

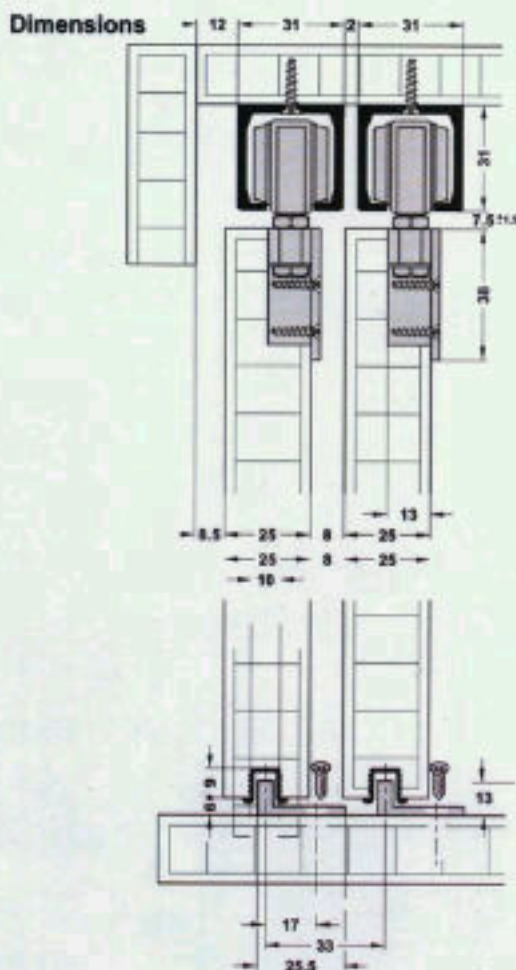

Type	Description
Deco - 80	Fitting set.1 doors.80 kg
Deco 20	Track Aluminium 2000mm
Deco 30	Track Aluminium 3000mm
Deco 40	Track Aluminium 4000mm
BRC - 040	Wall mounting Bracket with screw and nut
TP - 025	Guide Track,plastic.black.2500 mm

Type : Deco-100

Max Weight 110 kg

- For Wooden Door
- Door Thickness : min.25 mm
- Height Adjustment : +/- 15mm
- Material : Nylon Running Gear
- Running Gear : Top running 2 roller
With friction bearing gear
- Door Stop : Top stop with guide retainer

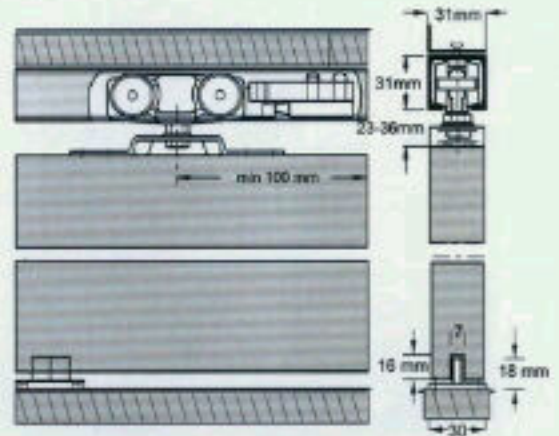

Sliding Door With Wall Mounting Bracket

★ Soft Close Option



Smooth and Silent Operation



FITTING SET

 2 pcs rolling gear 4 wheel/roller bearing with nut and screw-mounting nylon	 1 pc Door guide roller
 2 pcs Track buffer nylon	 1 pc wall mounting bracket with set screw steel galv
 Heavy-duty extruded aluminium tracks 2000mm, 3000mm, 4000mm, 6000mm	 Additional component Guide Track, Nylon Black

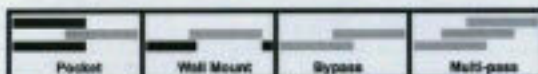

Type	Description
Deco 100	Fitting set 1 doors 100 kg
Deco 20	Track Aluminium 2000mm
Deco 30	Track Aluminium 3000mm
Deco 40	Track Aluminium 4000mm
TP - 025	Guide Track, plastic black 2500 mm

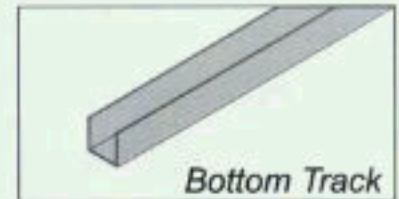
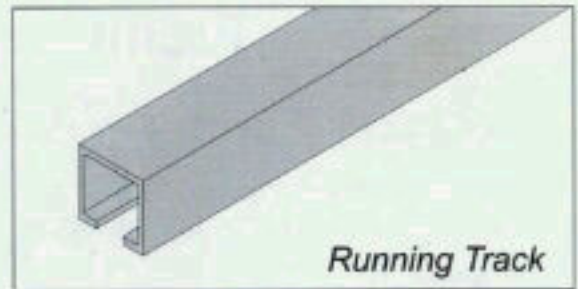
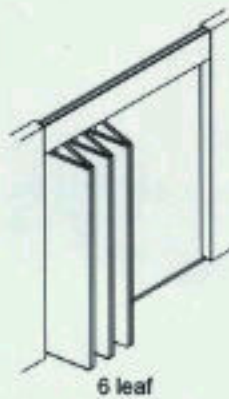
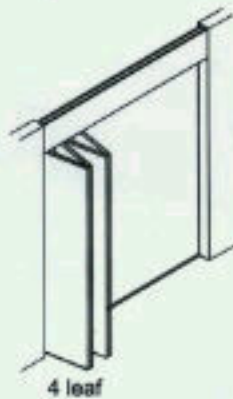

Features

- For large wall units or cabinets as well as for dividing panels
- Simple installation with no routing or grooving necessary
- Maximum running performance due to running gears with ball bearing nylon rollers
- Height adjustable

Technical data

- Max. door weight 40 kg per door leaf
- Min. door thickness 27 mm
- Max. door width 600 mm per door leaf

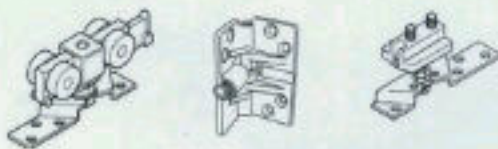
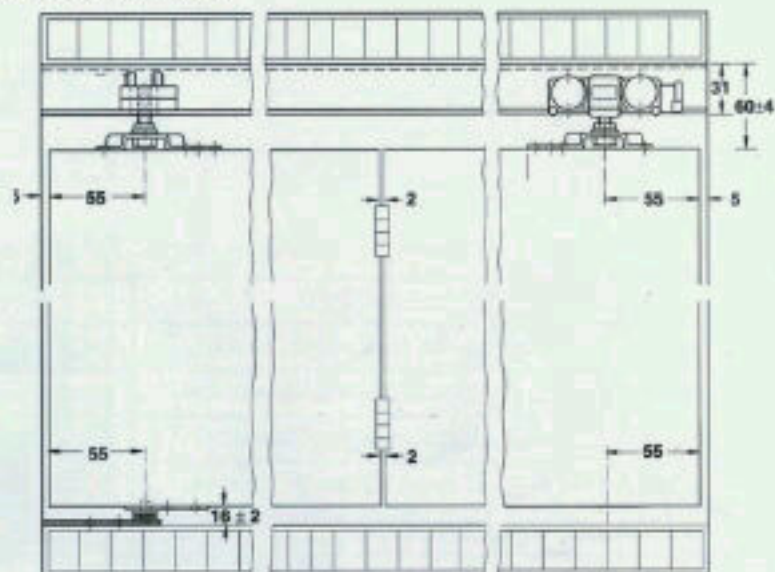

Type	Description
FDE - 11	Fitting set for 2 door
DECO - 20	Upper Track Aluminium 2000mm
DECO - 30	Upper Track Aluminium 3000mm
DECO - 40	Upper Track Aluminium 4000mm
CU - 20	Bottom Track Aluminium 2000mm
CU - 30	Bottom Track Aluminium 3000mm
CU - 40	Bottom Track Aluminium 4000mm
SOS-10	Concealed Hinge

Frameless Glass Sliding

Sliding glass door with soft close

Glass thickness 10 and 12mm
Max weight per glass door 80 kg and 100 kg

★ *Soft Close*

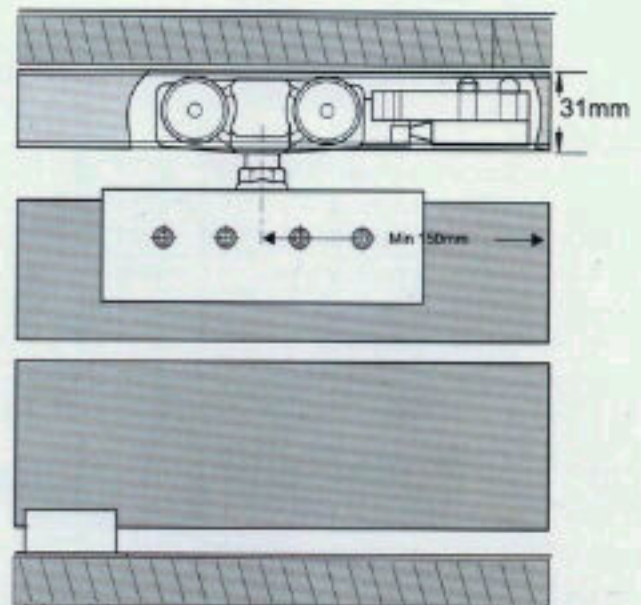
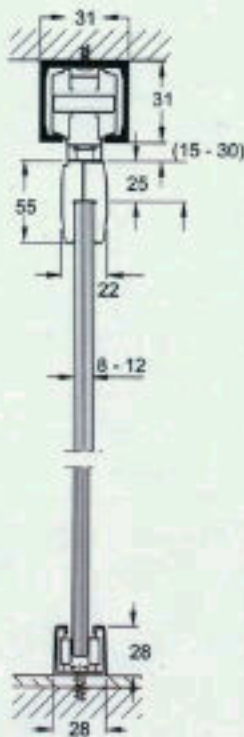

Type	Description
DM - 100	Fitting set for 1 door 80 kg
DM - 120	Fitting set for 1 door 100 kg
Deco - 20	Upper Track Aluminium 2000mm
Deco - 30	Upper Track Aluminium 3000mm
Deco - 40	Upper Track Aluminium 4000mm

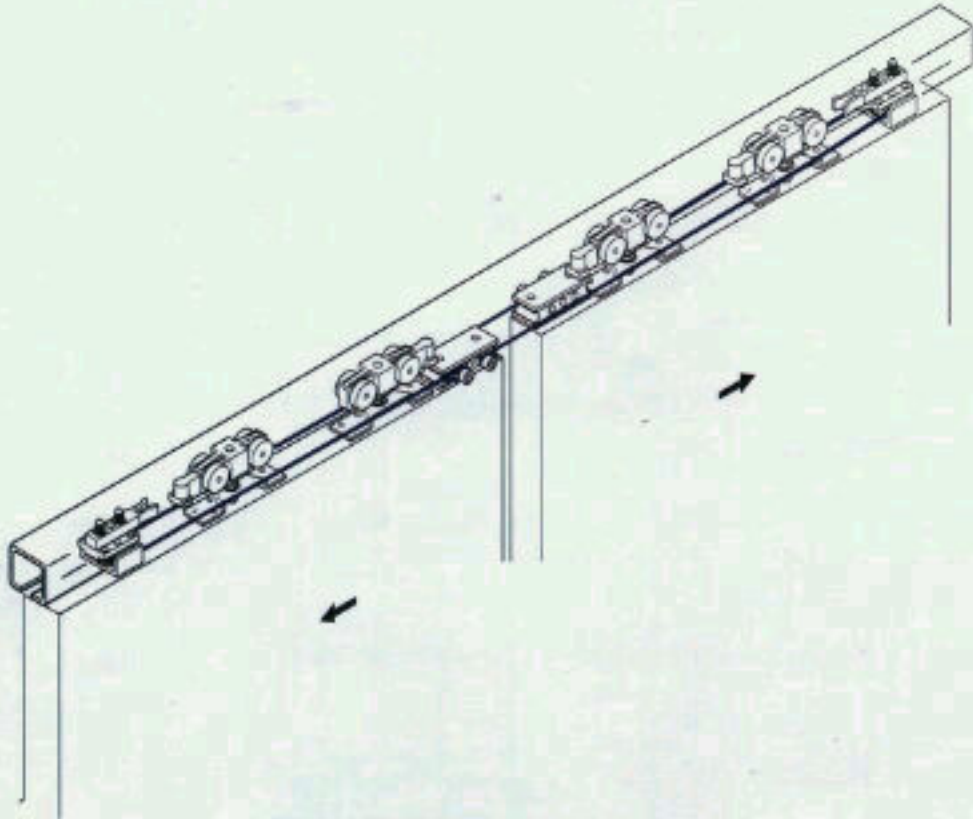

Synchro DECO

To upgrade sliding door fittings DECO 80, DECO 100
Max Height 40kg/door leaf



Synchro Set

Type : SYN - 01

Stopper with roller		2 pcs
Cable mounting block		2 pcs
Cable with plastic coating		10 mtr

To upgrade sliding door fitting DECO-80, DECO-100

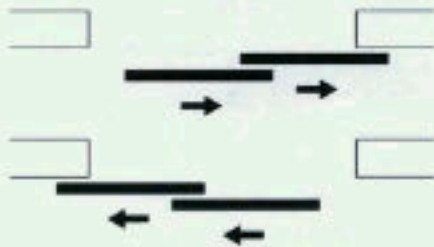

For 2 leaf sliding doors
Max. weight per door 80 kg/2 doors
Width 500 - 1200 mm

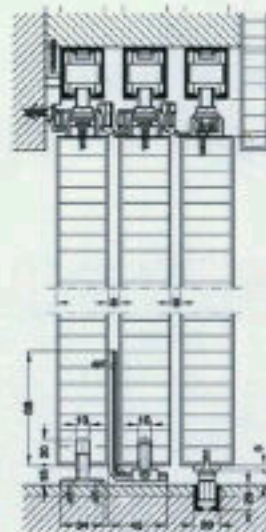
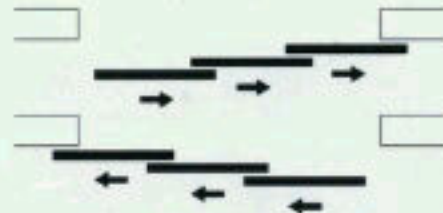

For 3 leaf sliding doors
Max. weight per door 80 kg/3doors
Width 500 - 1200 mm



Type	Description
TLP - 02	Fitting for 2 leaf sliding doors
TLP - 03	Fitting for 3 leaf sliding doors



High Performance



Easy to Install and Adjust

Type : SD 001

- Max weight 60kg
- For Door thickness 18 - 40mm
- For Wooden door
- For Aluminium door

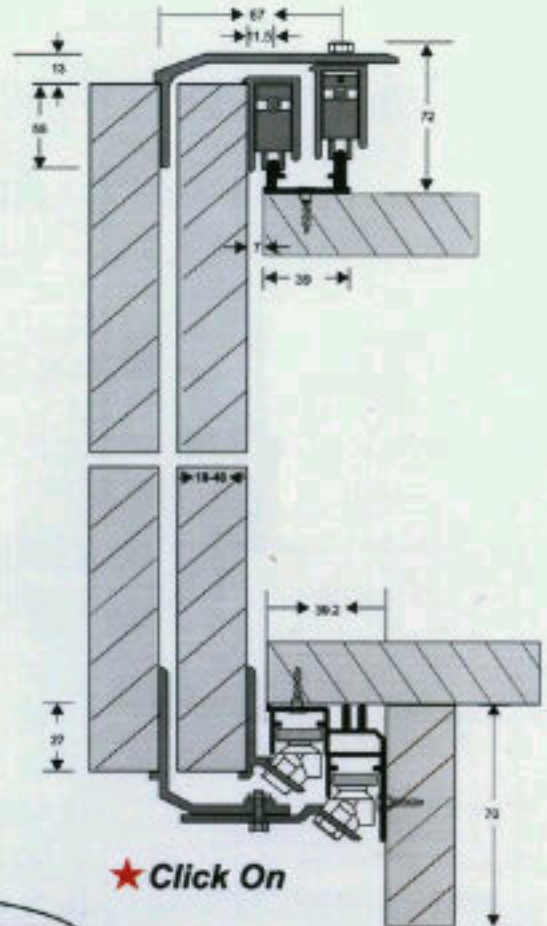

★ **Click On**

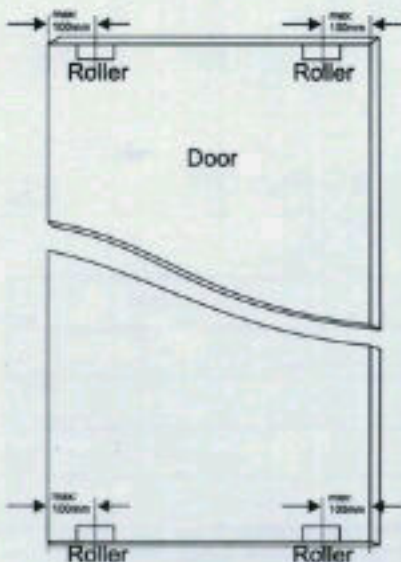

Type	Description
SD - 001	Fitting set.2 doors.60 kg
SD - 003	Fitting set.3 doors.60 kg
TA - 2.5 mtr	Upper and Bottom Track.Alu.2500 mm
TA - 3.5 mtr	Upper and Bottom Track.Alu.3500 mm

Wardrobe Lift with Soft Close



Type : Lift 1200 (soft closing)

Load capacity : 12 kg
Wardrobe width : 830 - 1150mm
Height : 830mm
Finish : Steel/stainless steel
with Chrome
Color : Black/Silver



Oval Rail Hanger
Euro Style (Adjustable)
(SOFT CLOSING DOUBLE RAILING)



Type : Lift 2000 (soft closing)

Load capacity : 10 kg
Wardrobe width : 830 - 1150mm
Height : 830mm
Finish : Steel/stainless steel
with Chrome
Color : Black.

Folding Door Fittings

For Wooden & Aluminium Door

Type : FD - 001

Deco Folding 60 kg

For door weights up to 30 kg (60 kg per pair of doors),
for folding doors free sliding or mounted to
carcase at one side with concealed hinges

Door Width	: Max.500 mm
Door Height	: 2.500 mm
Door Thickness	: 19 - 25 mm
Vertical Adjustment	: 1 - 4 mm
Height Adjustment	: +/-2mm

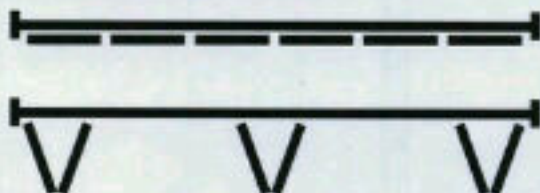

Type	Description
FD - 001	Fitting set,one side (2 leaf),incl hinge
FD - 002	Fitting set,free slide (2 leaf),incl hinge
FD - 003	Fitting set,one side (4 leaf),incl hinge
FD - 004	Fitting set,free slide (4 leaf),incl hinge
Deco-20	Track Aluminium 2000mm
Deco-30	Track Aluminium 3000mm
Deco-40	Track Aluminium 4000mm

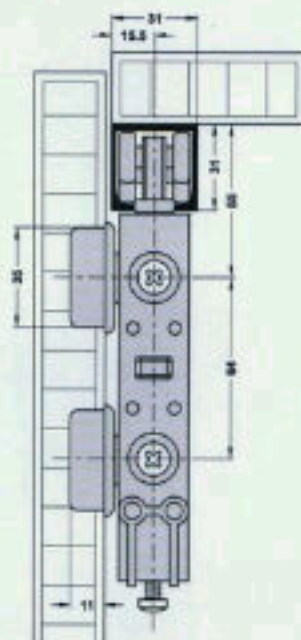
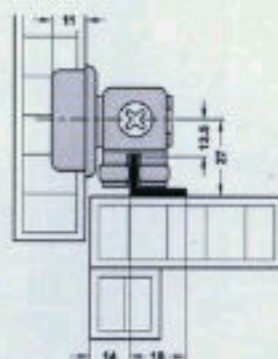
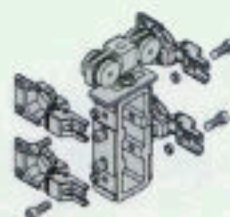
Top running gear,
for outer doorTop running gear,
for centre doorBottom guide,
for outer doorBottom guide,
for centre door

Rolled hinge

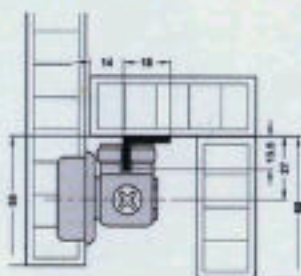
Hinge connection,
centre

Shiva (Vortfront sliding fitting)

- For Wooden Doors and
- Frame Aluminium Doors
- Weight :60kg

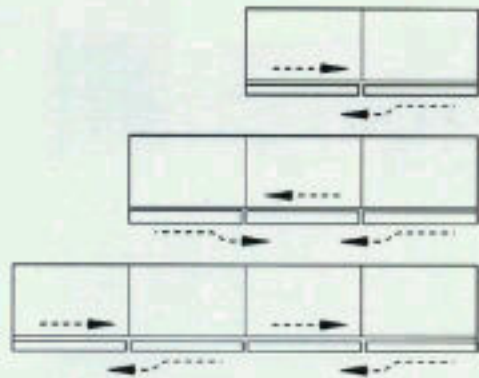
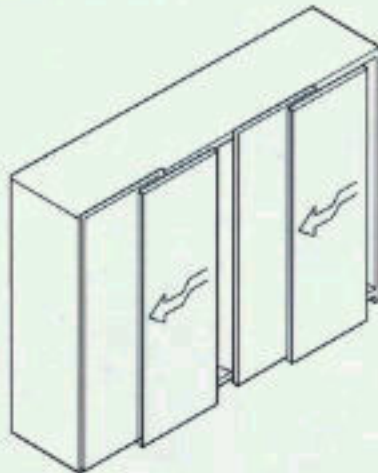

the menu of fitting with track and accessories

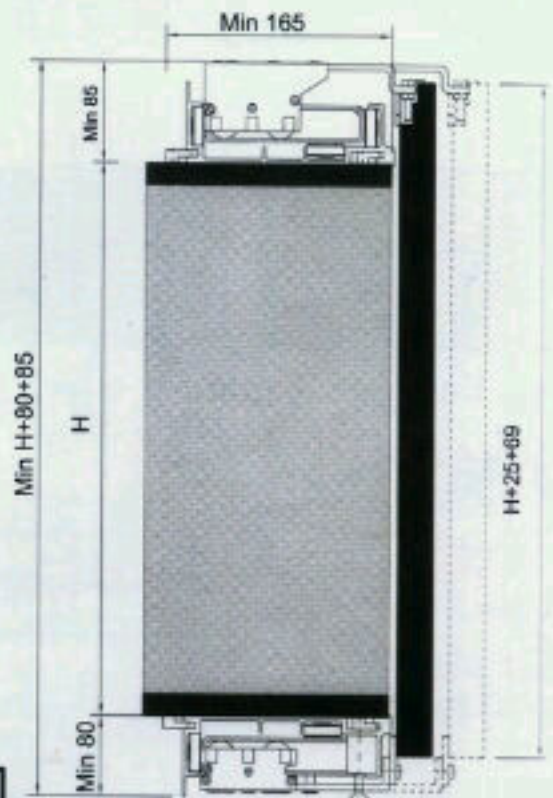
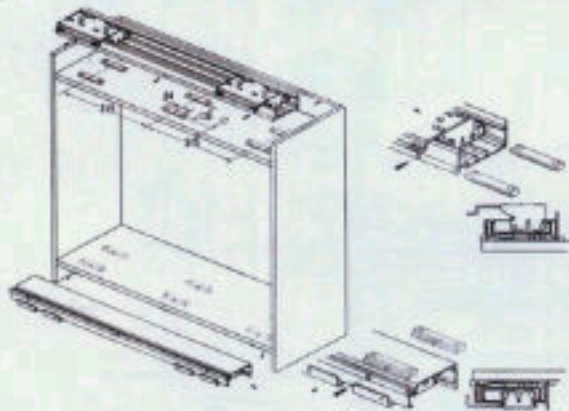

Type	Description
SHA2 - 80	Door width 500 - 800mm.2 doors
SHA2 - 100	Door width 800 - 1000mm.2 doors
SHA2 - 120	Door width 1000 - 1200mm.2 doors
SHA3 - 80	Door width 500 - 800mm.3 doors
SHA3 - 100	Door width 800 - 1000mm.3 doors
SHA3 - 120	Door width 1000 - 1200mm.3 doors

Juno Front Fitting



Material:
- Zinc alloy, Steel

Finish:
- Powder coated silver coloured

Soft Close

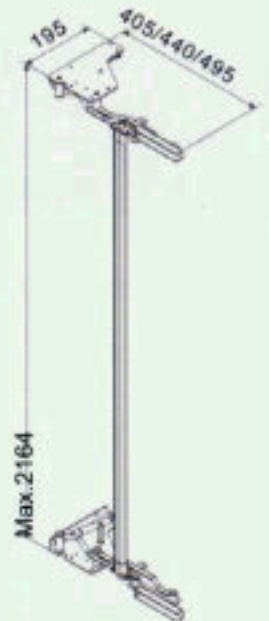

Easy Installation

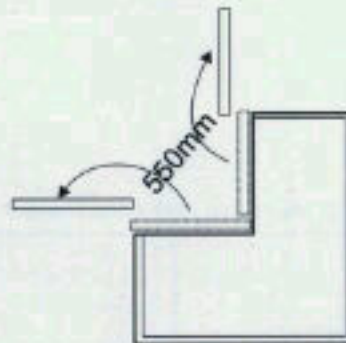

Connecting bar
2000mm

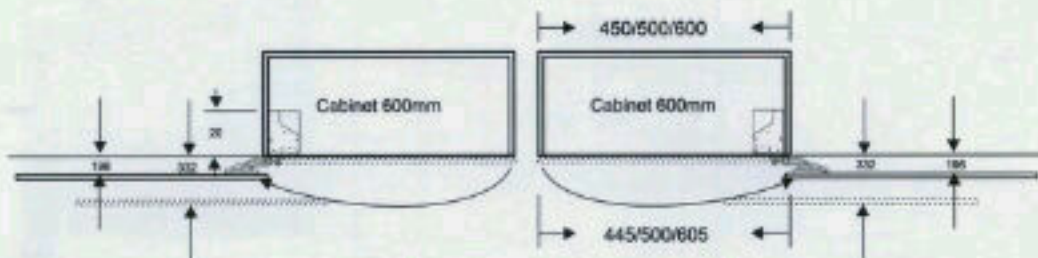

Type :	Moving Distance	H X W X D	Load Capacity	Width
UN - 450	445 mm	2164 X 405 X 200	Max.9 kg	450
UN - 500	490 mm	2164 X 440 X 200	Max.11 kg	500
UN - 600	583 mm	2164 X 495 X 200	Max.12 kg	600

Sliding Door Symmetric 80
Max.Weight perdoor leaf

- For 2 leaf sliding doors
- Symmetrical opening of 2 doors leaves
- Two-way suspension
- Height and side adjustable door leaves
- Quiet running action



Type	Description
SYN-02	Fitting set for doors,incl 2 pcs Upper Track 2.5mtrs

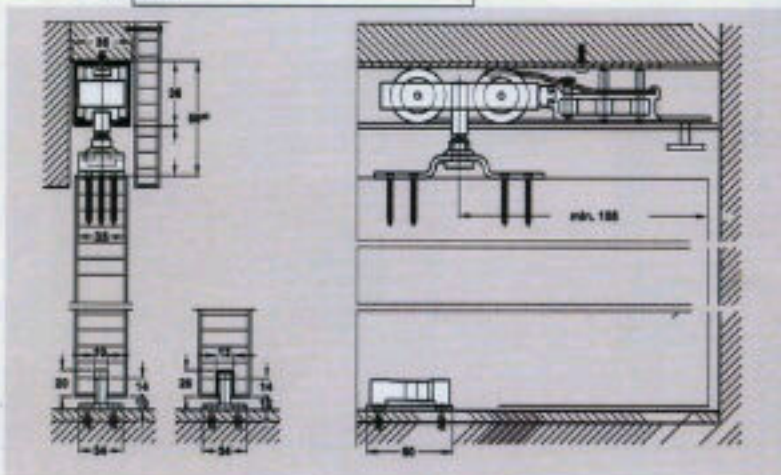
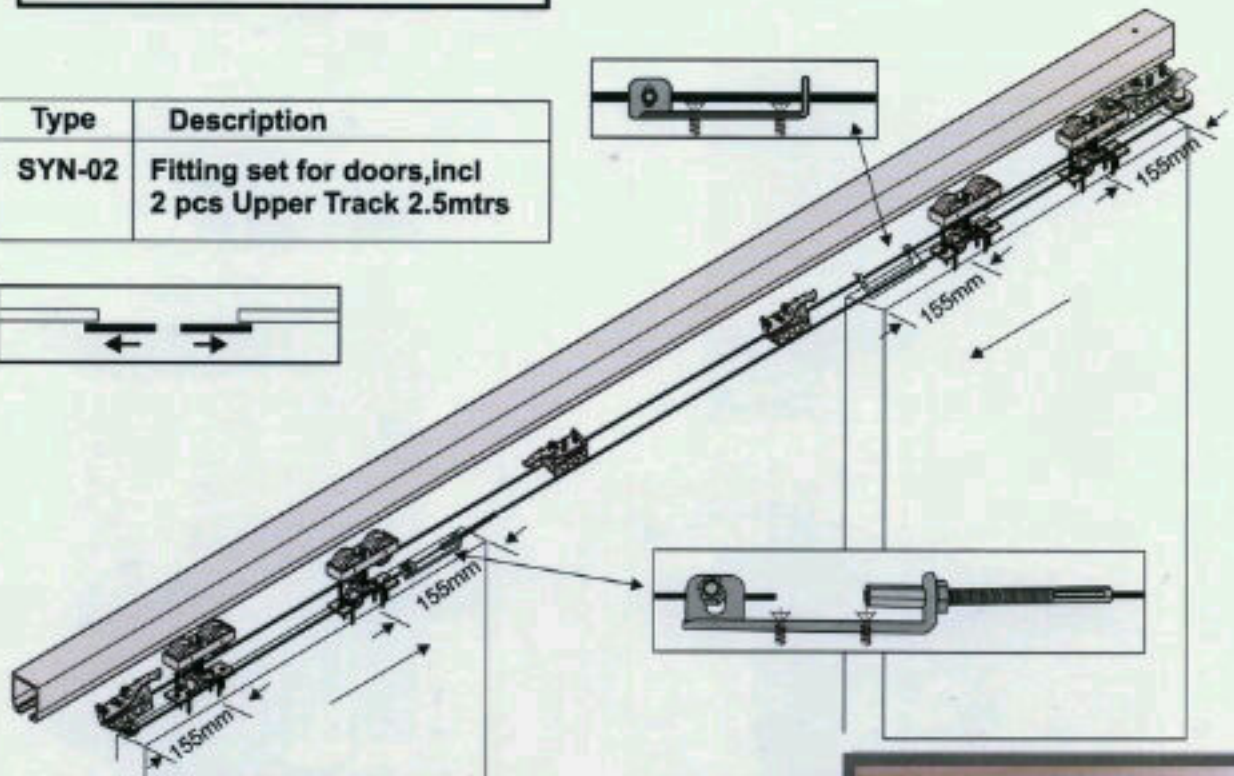
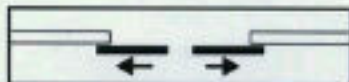

Sliding Vortfront With Soft Close**Type : SD 050**

- Max weight 50kg
- With Soft close
- For Door thickness 18 - 40mm
- For Wooden door
- For Aluminium door

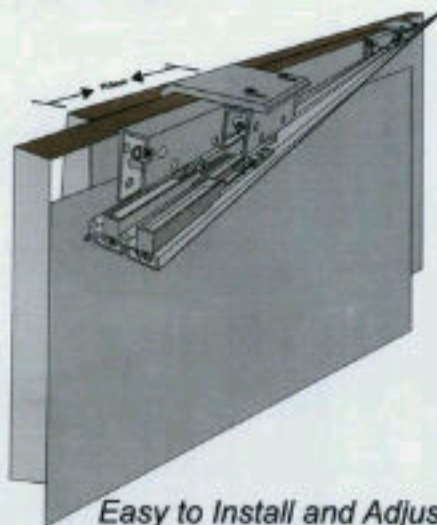
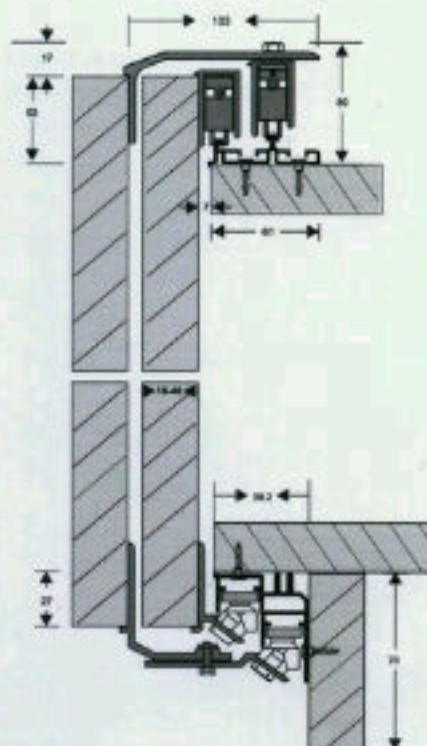
★ **Soft Close***High Performance**Easy to Install and Adjust*★ **Click On**

Type	Description
SD - 050	Fitting set.2 doors.50 kg
TA - 525	Upper and Bottom Track.Alu.2500 mm

Lift Up Flap Fittings Bi Fold

Type : JD - 008



- Material** : Screw-on runner, hinged lever made of steel, plastic hinges
- Finish** : Screw-on runner aluminium coloured, hinged lever galvanized and aluminium coloured, similar to RAL 9006 hinges grey, similar to RAL 9006
- Spring** : Gas loaded spring
- Carcase Height** : 520 mm (flap height 2 x 256 mm)
- Installation** : Screw fixing
Mounting instructions



Installation

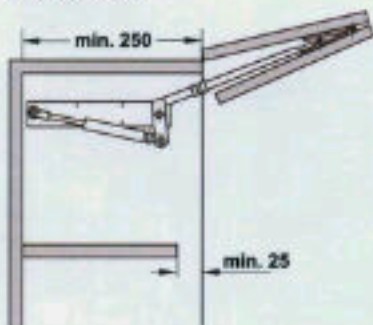

Counter Buffer, Hydraulic lever



- Doors closed softly and quietly.
- Easy positioning of device.
- Can be counter drilled or screw on adapter

**Lift Up Flap Fitting
With Soft Close
Type : JD - 007**



Material	: Steel
Finish	: Plastic coated, Grey
Spring	: 2 gas loaded springs
Flap weight	: 15 kgs
Installation	: Screw fixing
Width	: 576 - 865 mm
Height	: 320mm,max 450mm
Depth	: min 250mm
Front Adjustment	vertical \pm 3mm horizontal \pm 3mm

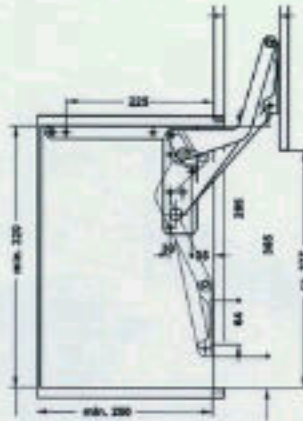

Counter Buffer,Hydraulic lever

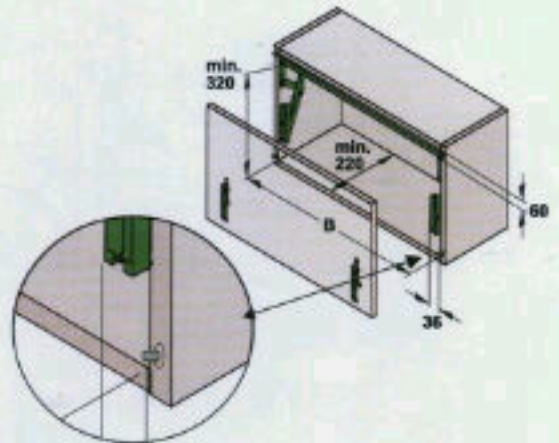

- Doors closed softly and quietly.
- Easy positioning of device.
- Can be counter drilled or screw on adapter

**Counter Buffer
Hidraulic lever**

Closing your cabinet doors with soft closing

With Adjustable Screw



The adjustable design
Can Suit Different Position

Type : DBF - 001
Finish : Zinc Alloy
Nickel Plated

Doors closed softly and quietly.

Silent Soft Closing System

Counter Buffer, Hidraulic lever



Type : DBF - 003
Finish : Plastic
Color : Dark grey

- Doors closed softly and quietly.
- Easy positioning of device.
- Can be counter drilled or screw on adapter



Lift Up Flap Fitting

Type : JD - 007

- | | |
|------------------|--|
| Material | : Steel |
| Finish | : Plastic coated, Grey |
| Spring | : 2 gas loaded springs |
| Flap weight | : 15 kgs |
| Installation | : Screw fixing |
| Width | : 576 - 865 mm |
| Height | : 320mm, max 450mm |
| Depth | : min 250mm |
| Front Adjustment | : vertical \pm 3mm
horizontal \pm 3mm |

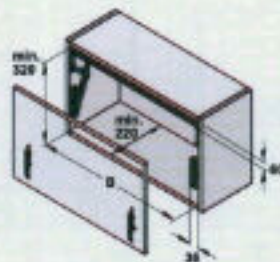



Device Soft Closing

- For Wooden Cabinet
- Weight 5 kg
- For Euro Slide & Ball Bearing Slide (without Detent-in)
- Width of gap $S = 10\text{mm} - 13.5\text{mm}$
- Finish : Plastic
- Color : Grey

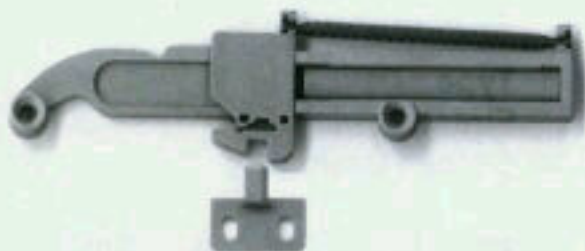

Type : Dev - 02

Instalation

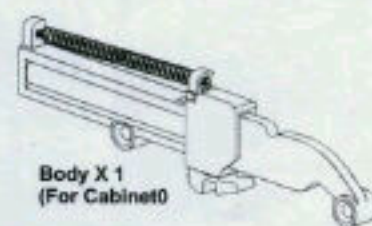
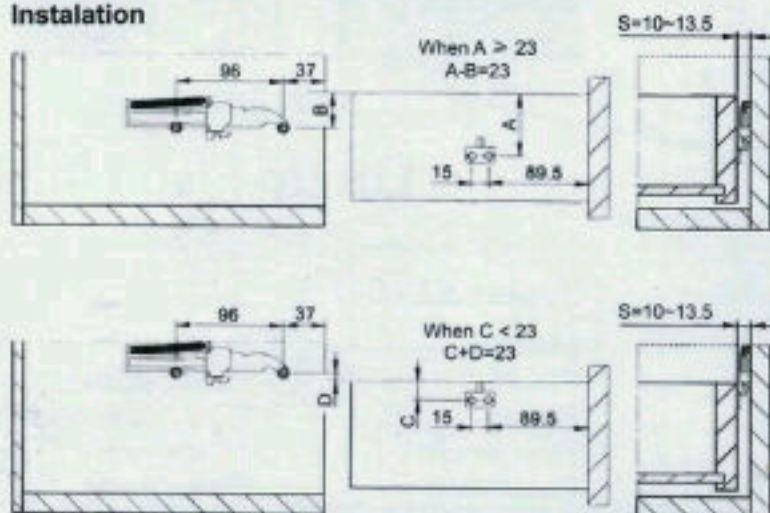

Body X 1
(For Cabinet)



Follower X 1
(For Drawer)

2 X Ø4X12L
2 X Ø4X12L

Adjustable Barrel Hinge/Pivot Hinge for Swing Doors

Features :
for aluminium swing doors
for wooden/aluminium window
Max : 45 kg

Finish: Stainless steel

Type : PH - 001

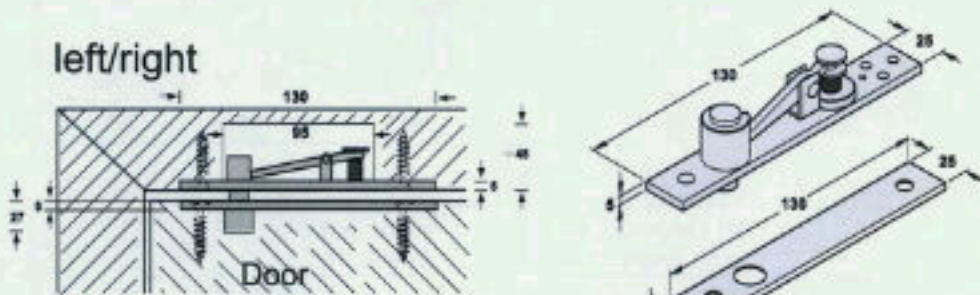

Top part with adjustable bolts to compensate for chamber dimensions of max. 20 mm

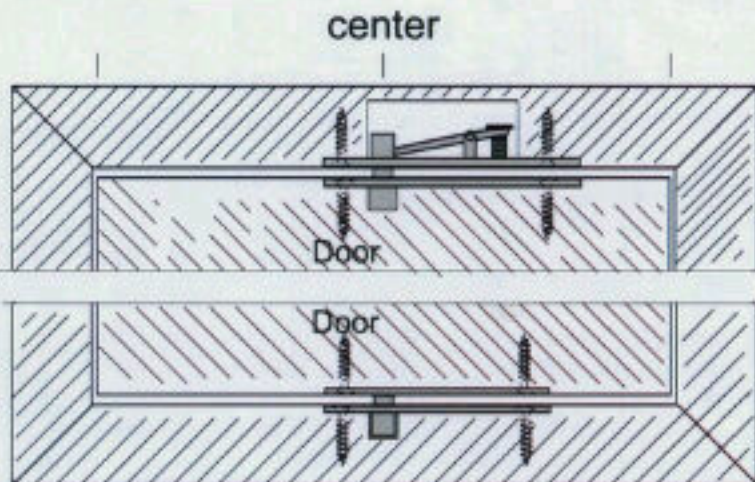
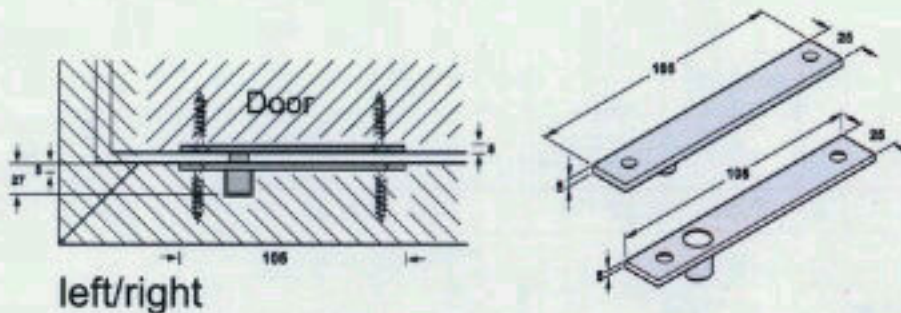

Concealed Hinge

Material : Steel
 Finish : Nickel plated
 Opening angle : 110°
 Cup diameter : \varnothing 35mm
 Cup depth : 12.5 mm



Full Overlay/ Crank 0 mm	Half Overlay/ Crank 9mm	Inset Door/ Crank 17mm
Type : EM 01	Type : EM 02	Type : EM 03

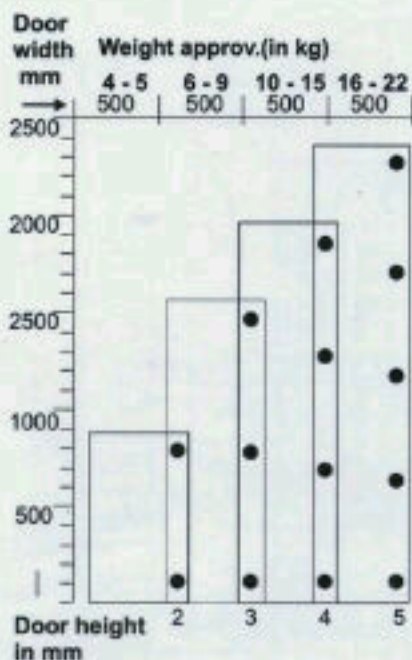

Drilling dimensions for cup fixing screw fixing

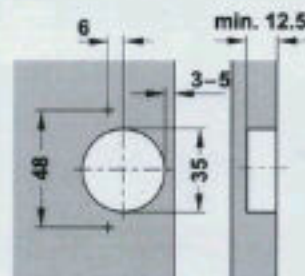

Drilling pattern 48/6

Drilling dimensions for cup fixing

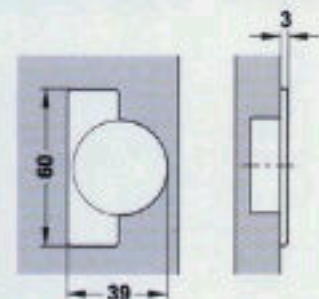

Push To Open Hinge

Material : Steel
 Finish : Nickel plated
 Opening angle : 110° C
 Cup diameter : $\varnothing 35\text{mm}$
 Cup depth : 12.5mm
 Fixing door to carcase : Click On



Click on



Rebound



Type : RBD 01

Full Overlay/ Crank 0 mm	Half Overlay/ Crank 9mm	Inset Door/ Crank 17mm
Type : PTO 01	Type : PTO 02	Type : PTO 03

Door width mm	Weight approx.(In kg)			
	4 - 5	6 - 9	10 - 15	16 - 22
500	500	500	500	500

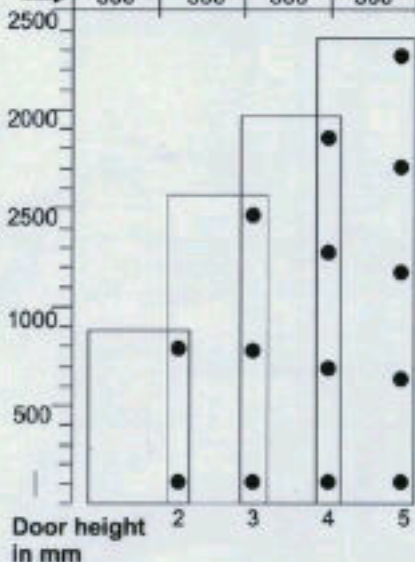

Drilling dimensions for cup fixing Screw fixing

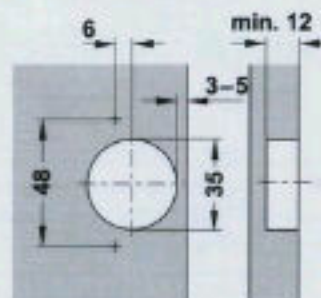

Drilling pattern 48/6

Drilling dimensions for cup fixing

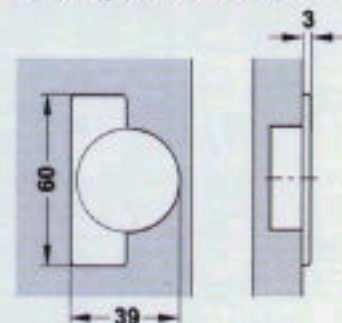

Soft Closing Hinge



Click on

Material : Steel
 Finish : Nickel plated
 Opening angle : 110° C
 Cup diameter : Ø35mm
 Cup depth : 11.5mm
 Fixing door to carcass : Click On



With Screw Adjuster



Smoothly



Silent & Soft



Euro Style

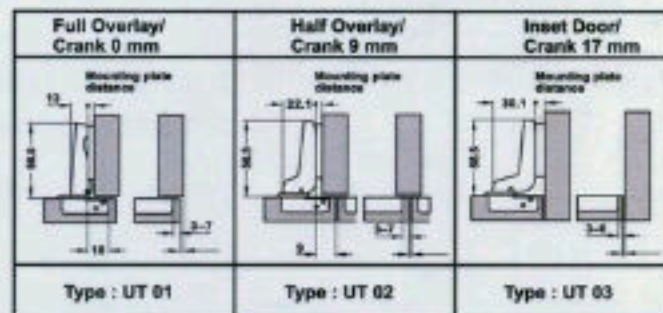
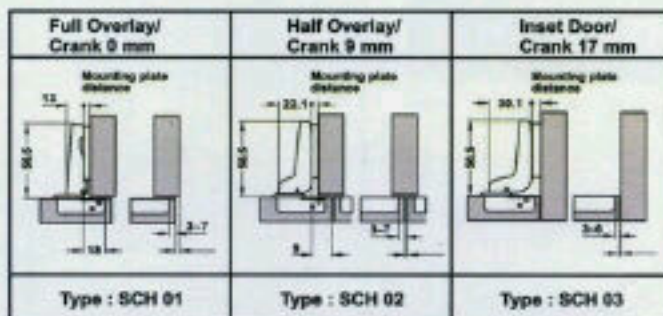
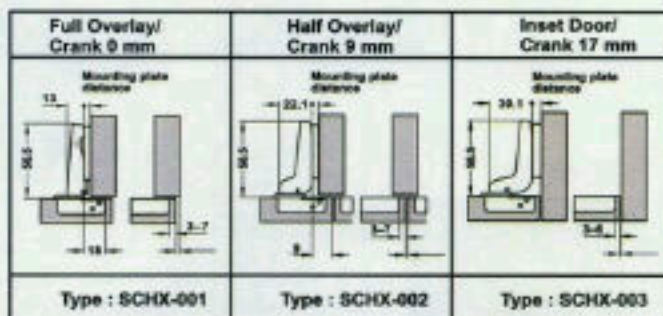
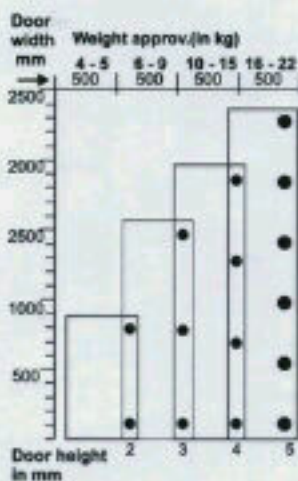

Drilling dimensions for cup fixing Screw fixing

Drilling dimensions for cup fixing

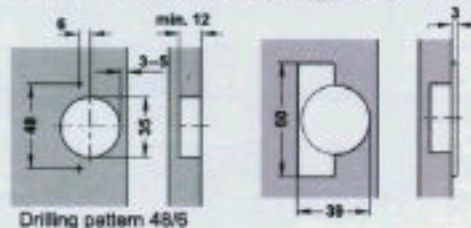

Profil Hinge



Material	: Steel
Finish	: Nickel plated
Opening angle	: 92°
Cup diameter	: \varnothing 40 mm
Cup depth	: 11.5mm
Cup distance	: 48 mm
Door tickness	: 24 Up
Fixing door to carcase	: Click On



★ **Soft Close**



with adjuster

Full Overlay/ Crank 0 mm	Half Overlay/ Crank 17 mm	Inset Door/ Crank 24 mm
<p>Mounting plate distance: 13 Cup distance: 3-12</p>	<p>Mounting plate distance: 22.1 Cup distance: 3-12</p>	<p>Mounting plate distance: 37.5 Cup distance: 3-6</p>
Type : PRH 01	Type : PRH 02	Type : PRH 03

Drilling dimensions for cup fixing

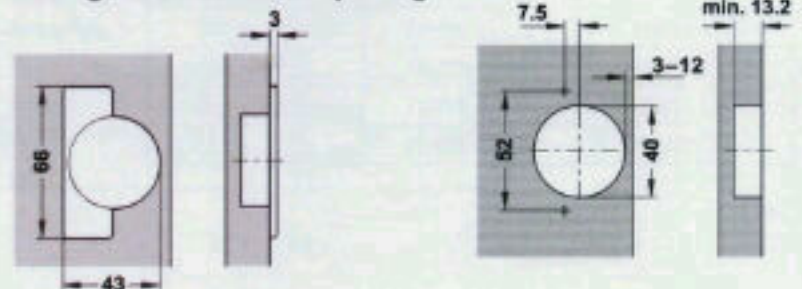

Silent Slide (silent wheel)
Load capacity up to 30 kg/prs
Material : Steel
Finish : Plastic coated white.
Type of closing : Self closing



Application and planning dimensions
Installation

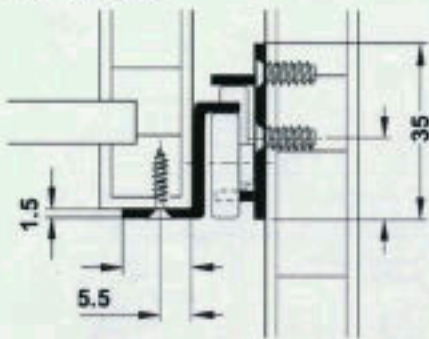

Application and planning dimensions

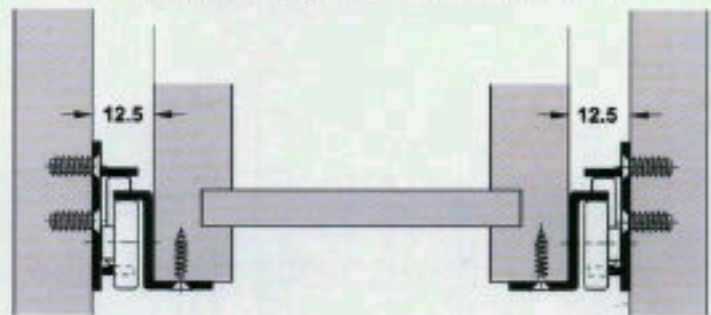

Installation Length	Extension Length	Type
300 mm	225 mm	ES - 30
350 mm	275 mm	ES - 35
400 mm	320 mm	ES - 40
450 mm	370 mm	ES - 45
500 mm	415 mm	ES - 50
550 mm	455 mm	ES - 55

Drilling dimensions

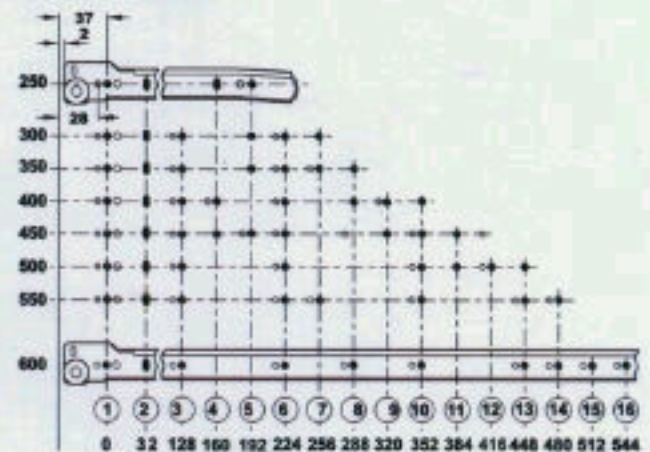



Slow Motion Tandem

Load Capacity Up to 40 kg/prs

Runner Length	Drawer Length	Load kg/prs	Max. Width	Min. Internal depth
300mm	290mm	30mm	500mm	290mm
350mm	340mm	30mm	550mm	360mm
400mm	390mm	35mm	600mm	410mm
450mm	440mm	40mm	650mm	460mm
500mm	490mm	35mm	700mm	510mm

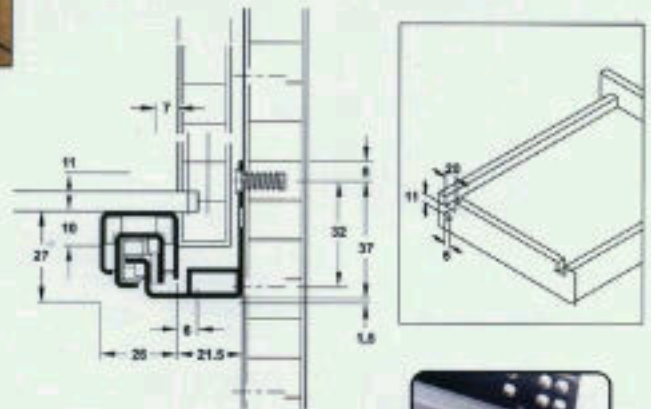

With Pin Clip

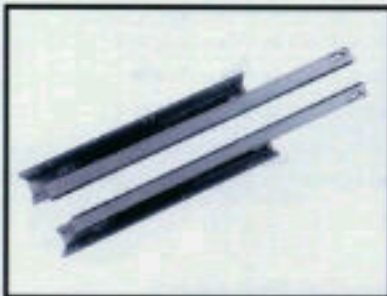

Single Extension

Tandem, Soft Closing-Single Extension

Type	Guide Length
TSMS - 300mm	Tandem.Slow Motion.Single Ext.300mm
TSMS - 350mm	Tandem.Slow Motion.Single Ext.350mm
TSMS - 400mm	Tandem.Slow Motion.Single Ext.400mm
TSMS - 450mm	Tandem.Slow Motion.Single Ext.450mm
TSMS - 500mm	Tandem.Slow Motion.Single Ext.500mm

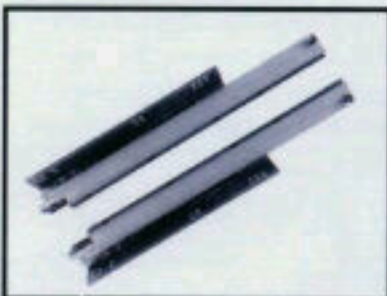

Full Extension

Tandem, Soft Closing-Full Extension

Type	Guide Length
TSMF - 300mm	Tandem.Slow Motion.Full Ext.300mm
TSMF - 350mm	Tandem.Slow Motion.Full Ext.350mm
TSMF - 400mm	Tandem.Slow Motion.Full Ext.400mm
TSMF - 450mm	Tandem.Slow Motion.Full Ext.450mm
TSMF - 500mm	Tandem.Slow Motion.Full Ext.500mm



Tandem Push To Open
Load Capacity : 40 kg



With Pin Clip

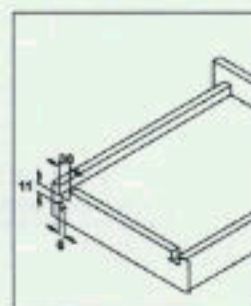
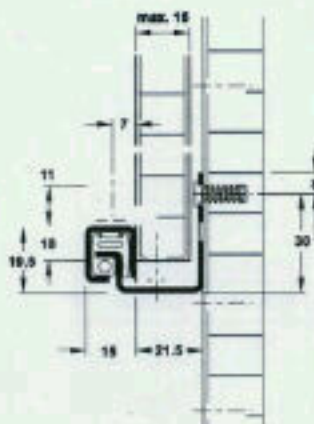

Runner Length	Drawer Length	Load kg/prs	Max. Width	Min. Internal depth
300mm	290mm	30mm	500mm	290mm
350mm	340mm	30mm	550mm	360mm
400mm	390mm	35mm	600mm	410mm
450mm	440mm	40mm	650mm	460mm
500mm	490mm	35mm	700mm	510mm



Single Extension



Full Extension

Tandem, Push To Open. Single Extension

Type	Description
TPTS-300	Tandem. Push to Open. Single Ext. 300mm
TPTS-350	Tandem. Push to Open. Single Ext. 350mm
TPTS-400	Tandem. Push to Open. Single Ext. 400mm
TPTS-450	Tandem. Push to Open. Single Ext. 450mm
TPTS-500	Tandem. Push to Open. Single Ext. 500mm

Tandem, Push To Open. Full Extension

Type	Description
TPTO-300	Tandem. Push to Open. Full Ext. 300mm
TPTO-350	Tandem. Push to Open. Full Ext. 350mm
TPTO-400	Tandem. Push to Open. Full Ext. 400mm
TPTO-450	Tandem. Push to Open. Full Ext. 450mm
TPTO-500	Tandem. Push to Open. Full Ext. 500mm

Type : TVL - 011A

FEATURES:

1. Easy to incorporate into a cabinet or bed.
2. 24V DC motor, quiet and safe operation.
3. Lifting noise is lower than 35db.
4. Loading capacity: 85 Kgs.
5. Adopt POP-UP design(3 segments), the height of mechanism is only 680mm when close.
6. With remote control and manual control, within 30 meters.
7. Piano painting on the surface of lift mechanism, or silver optional.
8. Max lifting speed: 32mm/ second.
9. Max stroke: 650mm.
10. Fixed by the metallic base.
11. Lift mechanism is made of aluminum chromium.
12. Universal bracket for 30-50 inches LCD/Plasma TV.
13. Package: 1 set/carton.
14. Power consumption: 30 Watts.
15. Net Weight: 28KGs, Gross Weight: 32KGs.

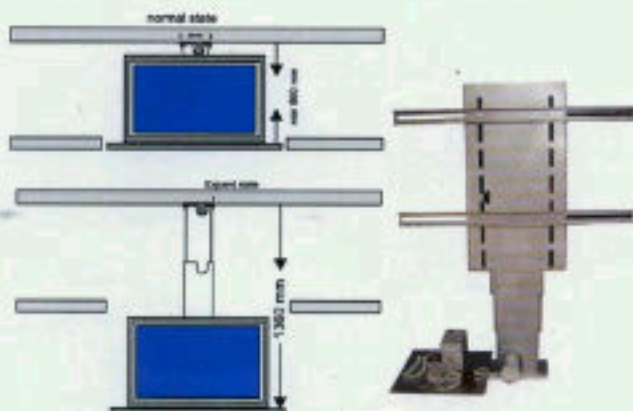

Type : TVL - 011B

FEATURES:

1. Easy to incorporate into a cabinet or bed.
2. 24V DC motor, quiet and safe operation.
3. Lifting noise is lower than 35db.
4. Loading capacity: 85 Kgs.
5. Adopt POP-UP design(3 segments), the height of mechanism is only 680mm when close.
6. With remote control and manual control, within 30 meters.
7. Piano painting on the surface of lift mechanism, or silver optional.
8. Max lifting speed: 32mm/ second.
9. Max stroke: 650mm.
10. Fixed by the metallic base.
11. Lift mechanism is made of aluminum chromium.
12. Universal bracket for 30-50 inches LCD/Plasma TV.
13. Package: 1 set/carton.
14. Power consumption: 30 Watts.
15. Net Weight: 28 KGs, Gross Weight: 32KGs.



Electrical TV Lift

Type : TVL - 12S (Swivel)

1. Top bracket 320 degrees automatically swivel, improved version of model No. TVL-12S, manually and remote controlled Users can watch TV at any viewing angles very conveniently.
2. 24V DC motor, quiet and safe operation.
3. Built-in control module and no need of extra control box and wires.
4. Max lifting speed: 30mm/ second.
5. Lifting noise is lower than 30db.
6. Height of mechanism when close: 870mm.
7. Max stroke: 720mm.
8. Made of carbon steel.
9. Loading capacity: 65 KGs.
10. Fixed by the hoops of mechanism back.
11. Universal bracket for 30-50 inches LCD/plasma TV, lifts for larger size of TVs are customized able.
12. Power consumption: 35 Watts.
13. Package: 1 set/ wooden box
14. Net weight: 48KGs, Gross weight: 59KGs.
15. Mechanism dimension[W x H x D] when close: 650 x 97 x 870mm



Available with Swivel Option

Motorized TV Wall Mount Bracket

Type : TVM - 06

1. Suitable for 32" - 46" LCD/plasma TV.
2. Controlled by remote within 30 meters.
3. Adjustable viewing angles:
UP/DOWN: 15 degrees; LEFT/RIGHT: 20 degrees.
4. Max loading capacity: 80 KGs.
5. Made of hard steel.
6. N.W: 24.40KGs; G.W: 27.80KGs

